

GENERAL TECHNICAL CHARACTERISTICS

Dielectric : Polypropylene film
 Construction : Dry construction, filled by solid resin
 Non-inductive type
 Case : **Extended metalized r film, dry construction**
 Leads: Tinned insert M6 or M8 fillde with resin

ELECTRICAL CHARACTERISTICS

Working teGperature : - 40 to + 85 °C
 Capacitance : 0.04 to 1μF
 Rated Voltage : 5000~10000Vdc
 Tolerance : ± 5%, ± 10%
 Dissipation factor: Geasured at 1000±20 Hz AND 25±5°C.
 When $C_r \leq 1.0\mu F$, 4×10^{-4} ;
 When $C_r > 1.0\mu F$, 6×10^{-4}

Life expectancy: 10,000 hours at U_n and 70°C
 (Hotspor temperature)



TEST GETHODS AND PERFORGANCES

Dielectric strength: 1.5 U_n (DC) applied for 10s at 25±5°C
 (1 minute for type test)

Test voltage terminal to case :3000Vac,(10s 50Hz 20± 5°C)

Insulation resistance : 3000s but need not exceed 30GΩ
 (typical value), after 1 minute of
 electrification at 100Vdc (25±5°C)

应用电路图:

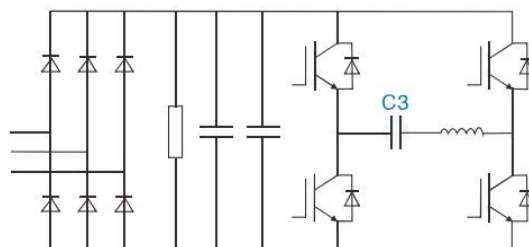
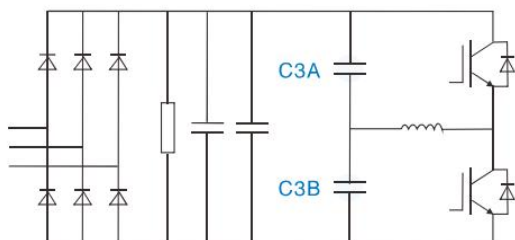

外型及尺寸/Outline drawing

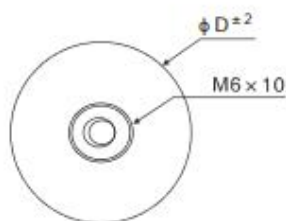
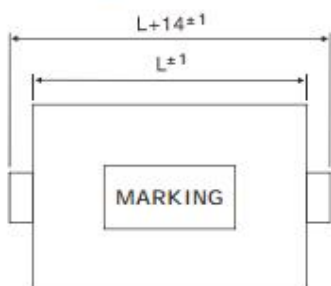

Outline drawing A...

外型及尺寸/Outline drawing

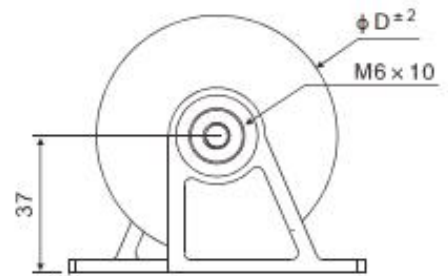
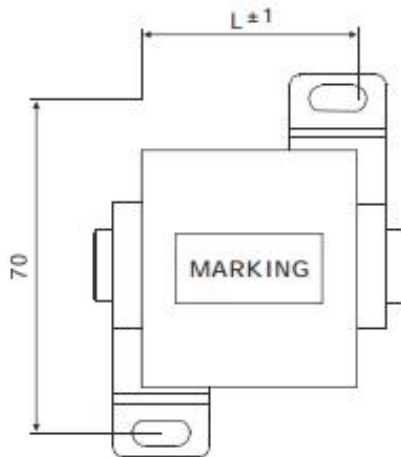

Outline drawing B...

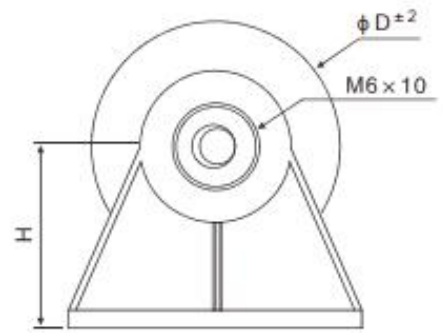
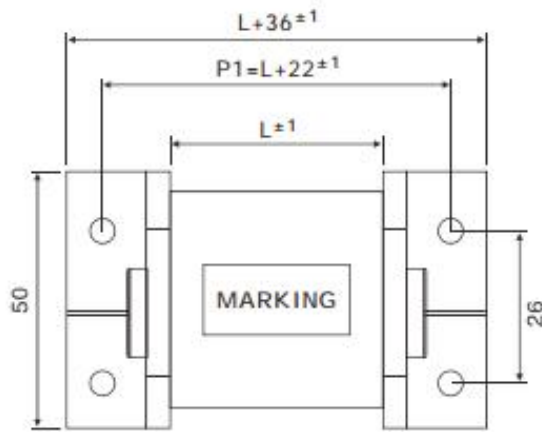

Outline drawing C...



Article table/参数表 (M8 铜头电极引出)

Part Number	Capacitance (μF)	Diameter (mm)	Length (mm)	ESL(nH)	du/dt (v/μs)	Irms max. (A)	Ipk(A)	ESR (mΩ)	
3000VAC (Un) 6000VDC									
DGR-3000-103	0.01	30	55	20	3000	30	30	2.0	
DGR-3000-403	0.04	55	55	20	3000	40	120	2.2	
DGR-3000-603	0.06	58	55	20	3000	50	180	1.9	
DGR-3000-803	0.08	63	55	20	3000	60	240	1.8	
DGR-3000-104	0.10	67	55	20	3000	70	300	1.6	
DGR-3000-124	0.12	72	55	20	3000	70	360	1.6	
DGR-3000-154	0.15	76	55	20	3000	70	450	1.6	
DGR-3000-204	0.20	90	55	20	3000	75	600	1.5	
DGR-3000-224	0.22	94	55	20	3000	80	660	1.5	
超高压系列									
Part Number	CAP μF	Dimension (mm)				du/dt v/μs	Ipeak A	ESR@ 1.0kHz	Irms@25C @10kHz
		L	D	T	Output				
Urms8000Vac Un15000Vdc									
DGR8000J0.05-*-*#	0.05	110	50	6.0	M6	2000	100	2.2	30A
DGR8000J0.10-*-*#	0.10	110	50	6.0	M6	2000	200	2.0	30A
DGR8000J0.20-*-*#	0.20	140	50	6.0	M8	2000	400	2.0	50A
DGR8000J0.40-*-*#	0.40	140	75	6.0	M8	1500	600	2.0	60A
DGR8000J0.80-*-*#	0.80	140	110	6.0	M8	1500	1200	1.8	80A

更多规格，为您提供，欢迎咨询！

How to Order:

DGR- 3000 - 334 K M8

